



swiss bed concept



DREAM LINE

POLSTERBETTEN | LITS REMBOURRÉS | UPHOLSTERED BEDS



Hasena – mein Bett

Hasena – mon lit | Hasena – my bed

Beständige Passion

Une passion constante
Enduring Passion



Mehr als ein Lebenswerk

Als Familienunternehmen gegründet, überzeugen wir seit über 70 Jahren mit hoher Qualität und Vielseitigkeit im Bereich Schlafzimmermöbel.

Plus que l'œuvre d'une vie

Fondée en tant qu'entreprise familiale, nous convainquons depuis plus de 70 ans par notre qualité élevée et notre polyvalence dans le domaine des meubles de chambre à coucher.

More than a life's work

Founded as a family business, we have been impressing with high quality and versatility in the field of bedroom furniture for over 70 years.

swiss bed concept



swiss bed concept

Ein cleveres Baukastensystem

Sie wählen Ihren favorisierten Bettrahmen aus und kombinieren dazu Füsse und Kopfteil Ihrer Wahl. Dabei können Sie quer durch die Kollektionen auf unterschiedliche Materialien und Farben zugreifen.

Un système modulaire astucieux

Vous choisissez votre cadre de lit préféré et le combinez avec les pieds et les têtes de lit de votre choix. Vous pouvez choisir parmi une variété de matériaux et de couleurs dans toutes les collections.

A clever modular system

You choose your favourite bed frame and combine it with the feet and headboards of your choice. You can choose from a variety of materials and colours throughout the collections.

5 Jahre Garantie

Service de livraison rapide
5 years warranty



Unser Versprechen

Vom Baum zum Bett – mittels handwerklicher Perfektion und hochwertigen Materialien. Sie erhalten 5 Jahre Garantie auf die Material- und Oberflächenbeschaffenheit, sowie die fachgerechte Verarbeitung aller Modelle ab Kaufdatum. Weitere Informationen finden Sie auf unserer Website.

Notre promesse

De l'arbre au lit – grâce à un artisanat parfait et des matériaux de haute qualité. Vous bénéficiez d'une garantie de 5 ans sur la qualité des matériaux et des surfaces, ainsi que sur la fabrication professionnelle de tous les modèles à compter de la date d'achat. Vous trouverez plus d'informations sur notre site Internet.

Our promise

From tree to bed – by means of perfect craftsmanship and high-quality materials. You receive a 5-year guarantee on the material and surface quality, as well as the professional workmanship of all models from the date of purchase. Further information can be found on our website.

Schnellieferservice

Service de livraison rapide
Quick delivery service



Komfort ohne Wartezeit

Mit unserem Schnellieferservice «PRONTO» können wir eine grosse Auswahl an Betten mit Beimöbeln und alle Modelle aus Edition pronto, Dream pronto und Boxspring pronto ab Lager liefern.

Le confort sans attente

Notre service de livraison rapide « PRONTO » permet de livrer un large choix de lits, de meubles d'appoint et tous les modèles de l'Édition Pronto, Dream pronto et Boxspring Pronto à partir du stock.

Comfort without waiting

With our quick delivery service «PRONTO» we can offer a large selection of beds with ancillary furniture and all models from models from Edition pronto, Dream pronto and Boxspring pronto from stock.





Vielseitig kombinierbar

Unser ausgeklügeltes Baukastensystem «swiss bed concept» bietet eine riesige Auswahl an Füßen, Kopfteilen und Beimöbeln. Darüber hinaus umfasst es verschiedene Stoff-, Kunstleder- und Lederbezüge sowie diverse Holz- und Metallausführungen. Abgestimmte Lattenroste und Matratzen komplettieren unsere Betten zur Wohlfühloase.

Combinable à versatile

Notre système modulaire sophistiqué «swiss bed concept» propose un choix énorme de pieds, têtes de lits et accessoires. Par ailleurs le comporte différents tissus, cuirs synthétiques et véritables, ainsi que diverses variantes de bois et métal. Des sommiers à lattes et des matelas adaptés complètent nos lits pour un espace bien-être.

Versatile combinable

Our ingenious modular system «swiss bed concept» offers a huge selection of feet, headboards and accessories. In addition, it includes different fabrics, synthetic leather and real leather covers and different wood and metal versions. Matching slatted frames and mattresses complete our beds to an oasis of well-being.

Nachhaltigkeit bei Hasena

Unser wichtigster Lieferant, die Natur, ist sensibel und benötigt lange Regenerationszeiten bei Überbeanspruchung. Wir respektieren die von uns genutzten Ökosysteme und stellen unsere Produkte nachhaltig und mit hohem sozialen Engagement her.



Soziale Verantwortung

Responsabilité sociale
Social responsibility



Holzoberflächen

Surfaces en bois
Wood surfaces



Stabil im Aufbau

Unsere Betten überzeugen durch eine hohe Stabilität. Mittels Einsatz verschiedener Traversen ist eine gesamthafte Belastung von 300 bis 450 kg, inklusive Lattenroste und Matratzen, möglich.

Construction robuste

Nos lits sont convainçants par leur grande stabilité. En utilisant différentes fermes, une charge totale de 300 à 450 kg, y compris les sommiers à lattes et les matelas, est possible.

Solid in construction

Our beds convince with their high stability. By using different trusses, a total load of 300 to 450 kg, including slatted frames and mattresses, is possible.

Durabilité chez Hasena

Notre fournisseur le plus important, la nature, est sensible et nécessite un long temps de régénération en cas de surutilisation. Nous respectons les écosystèmes que nous utilisons et fabriquons nos produits de manière durable et avec un haut niveau d'engagement social.



Holzbeschaffung

Approvisionnement en bois
Wood procurement



Recycelte Stoffe

Tissus recyclés
Recycled fabrics



Einfach in der Montage

Unser Betten-System begeistert durch einen einfachen Aufbau mit leicht verständlicher Montageanleitung sowie hochwertigen Verbindungselementen, welche einen vielfachen Ab- und Wiederaufbau ermöglichen.

Montage facile

Notre système de lits séduit par une installation facile grâce aux instructions de montage bien compréhensibles ainsi que par les éléments de fixation haut de gamme permettant de monter et démonter les lits à de nombreuses reprises.

Solid in construction

Our beds convince with their high stability. By using different trusses, a total load of 300 to 450 kg, including slatted frames and mattresses, is possible.

Sustainability at Hasena

Our most important supplier, nature, is sensitive and needs long regeneration times in case of overuse. We respect the ecosystems we use and manufacture our products sustainably and with a high level of social commitment.



Produktion Massivholz

Production bois massif
Manufacturing solid wood



Energiegewinnung

Production énergétique
Production of energy



3. Preiskategorie | 3^e catégorie de prix | 3rd price range

Alpina 390–394, 100% Polyester



390 lightgrey **391 anthrazit** **392 red** **393 navy** **394 smoke**

Boucle 770–773, 90% Polyester, 5% Baumwolle | Coton | Cotton, 5% Polyacryl | Polyacrylique



770 ivory **771 grey** **772 fresco** **773 mouse**

Boston 650–654, Oberfläche | Surface: 100% Polyester, Basis | Base: 70% Polyester, 30% Baumwolle | Coton | Cotton



650 clay **651 bean** **652 mocca** **653 turtle** **654 tizo**

Tocco 710–712, 100% Polyester



710 white **711 creme** **712 chocolate**

Buffalo 720–722, 100% Polyester



720 shale **721 grey** **722 espresso**

Campos 372–376, Kunstleder | Cuir synthétique | Synthetic leather

Oberfläche | Surface: 100% Polyurethan | Polyurethane, Basis | Base: 71% Polyester, 29% Baumwolle | Coton | Cotton



372 blanc **373 creme** **374 cafe** **375 nero** **376 kit**

Capo 760–765, 100% Polyester



760 anthracit **761 grey** **762 rose** **763 linen** **764 light brown** **765 taupe**

Casual 330–334, Kunstleder | Cuir synthétique | Synthetic leather

Oberfläche | Surface: 100% Polyurethan | Polyurethane, Basis | Base: 60% Polyester, 40% Baumwolle | Coton | Cotton



330 sahara **331 cannelle** **332 cognac** **333 olive** **334 carbon**

Cyclo 730–731, 100% PET recycelt | recyclé | recycled 



730 cream **731 macciato**

Fusio 750–752, 100% Polyester



750 shell **751 anthracit** **752 musk**



Informationen zu Recycling PET und PES
 Informations sur le recyclage du PET et du PES
 Further information on recycling PET and PES

Stoff- und Lederauswahl | Choix de tissus et cuirs | Choice of fabrics and leathers

3. Preiskategorie | 3^e catégorie de prix | 3rd price range

Kitana 600–604, 100% Polyester



600 beige

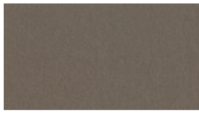

601 nougat



602 grigio



603 aqua



604 anthrazit

Ranch 660–664, 100% Baumwolle | Coton | Cotton



660 stone



661 grit



662 jeans



663 indigo



664 hunter

Bei der Stoffausführung Ranch wird in der Produktion mittels Waschung ein charakteristischer Vintage-Look erzielt. Lors de la production par le biais de différents lavages, un

look vintage caractéristique est donné au tissu Ranch. In the Ranch fabric version, a characteristic vintage look is achieved in production by way of washing.

Rinovo 700–701, 100% Polyester recycelt | recyclé | recycled 



700 anthracit



701 taupe

Ritorno 640–641, 100% Polyester recycelt | recyclé | recycled 



640 chiaro



641 anthracit

Velluto 740–742, Oberfläche | Surface: 100% Polyester Basis | Base: 90% Polyester, 10% Baumwolle | Coton | Cotton



740 grey



741 ivory



742 coffee

4. Preiskategorie | 4^e catégorie de prix | 4th price range

Real* 505–516, EchtLeder | Cuir véritable | Real leather

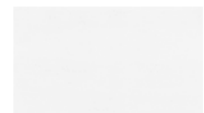

505 bianco



506 ecru



507 creta



508 moro



509 ardesia



513 falda



514 cenere

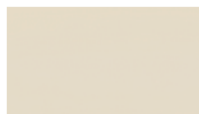

515 panna



516 notte

Vintage* 520 + 521, Echtleder | Cuir véritable | Real leather



520 fango



521 marone

Vintage ist ein Leder, welches mit Wachs behandelt wird um eine «Used-Optik» zu erhalten.

Vintage est un cuir véritable qui est traité à la cire afin d'obtenir un « aspect usé ».

Vintage real leather is treated with wax to achieve a «Used-Look».

Alpina, Boucle, Boston, Buffalo, Capo, Cyclo, Fusio, Kitana, Ranch, Rinovo, Ritorno, Tocco und Velluto können chemisch gereinigt werden. Die abgebildeten Farben können von den Originalfarben und Strukturen abweichen.

*Narben, Farb- und Strukturunterschiede sowie Faltenbildung sind Natureigenschaften von echtem Leder. Leder enthält nichttextile Teile tierischen Ursprungs.

Nous conseillons un nettoyage à sec pour les matières Alpina, Boucle, Boston, Buffalo, Capo, Cyclo, Fusio, Kitana, Ranch, Rinovo, Ritorno, Tocco et Velluto. Les couleurs et les structures des illustrations peuvent être différentes des couleurs et des structures originales.

*Les cicatrices, les différences de teinte et de structure ainsi que la formation de plis sont des marques naturelles du cuir véritable. Le cuir contient des éléments non textiles d'origine animale.

The covers Alpina, Boucle, Boston, Buffalo, Capo, Cyclo, Fusio, Kitana, Ranch, Rinovo, Ritorno, Tocco and Velluto can be dry cleaned. The pictured colours can be different than the original colours and structure

*Any marks, differences of colour or structure or wrinkle formations are natural characteristics of real leather. Leather includes non-textile parts of animal origin.

Ciara 23/4S

Dimension

90, 100, 120, 140, 160, 180, 200 × 200, 210, 220 cm

Kopfteil **Ripo**

Füsse **Arc** 20, 25 cm

Nachttisch **Styly** 43/43/48 cm

Bank **Sola** 140/37/38 cm

Alle Polsterteile in Kitana grigio 602

Alle Holzteile in Eiche bright, geölt

Tête de lit **Ripo**

Pieds **Arc** 20, 25 cm

Table de nuit **Styly** 43/43/48 cm

Banquette **Sola** 140/37/38 cm

Toutes les parties rembourrées en Kitana grigio 602

Toutes les parties en bois en chêne bright, huilé

Headboard **Ripo**

Feet **Arc** 20, 25 cm

Bedside table **Styly** 43/43/48 cm

Bench **Sola** 140/37/38 cm

All upholstery parts in Kitana grigio 602

All wooden parts in oak bright, oiled



Ciara 28/3S

Dimension

140, 160, 180, 200 × 200, 210, 220 cm

Kopfteil **Julia**

Füsse **Tondo** anthracit 20 cm

Nachttische **Nali** anthracit Ø 48/52 cm

Bank **Topa** anthracit 144/44/38 cm

Kommode **Incentro** anthracit 135/50/86 cm

Alle Polsterteile in Boston turtle 653

Alle Holzteile in Kernbuche natur, geölt

Tête de lit **Julia**

Pieds **Tondo** anthracit 20 cm

Table de nuit **Nali** anthracit Ø 48/52 cm

Banquette **Topa** anthracit 144/44/38 cm

Commode **Incentro** anthracit 135/50/86 cm

Toutes les parties rembourrées en Boston turtle 653

Toutes les parties en bois en hêtre coeur rouge naturel, huilé

Headboard **Julia**

Feet **Tondo** anthracit 20 cm

Bedside table **Nali** anthracit Ø 48/52 cm

Bench **Topa** anthracit 144/44/38 cm

Chest of drawers **Incentro** anthracit 135/50/86 cm

All upholstery parts in Boston turtle 653

All wooden parts in heart beech natural, oiled





Moon 18/3S

Dimension

140, 160, 180, 200 × 200, 210, 220 cm

Kopfteil **Orion**

Kufen **Slid** anthracit 20, 25 cm

Nachttisch **Lina** anthracit Ø 45/52 cm

Kommode **Quatrine** anthracit 90/50/86 cm

Alle Polsterteile in Boucle ivory 770

Alle Holzteile in Nussbaum, geölt

—

Tête de lit **Orion**

Patins **Slid** anthracit 20, 25 cm

Table de nuit **Lina** anthracit Ø 45/52 cm

Commode **Quatrine** anthracit 90/50/86 cm

Toutes les parties rembourrées en Boucle ivory 770

Toutes les parties en bois en noyer, huilé

—

Headboard **Orion**

Vats **Slid** anthracit 20, 25 cm

Bedside table **Lina** anthracit Ø 45/52

Chest of drawers **Quatrine** anthracit 90/50/86 cm

All upholstery parts in Boucle ivory 770

All wooden parts in walnut, oiled









Moon 18/4S

Dimension

140, 160, 180, 200 × 200, 210, 220 cm

Kopfteil **Talma**

Füße **Tondo** anthracit 20 cm

Nachttische **Nali** anthracit Ø 48/52 cm

Bank **Topa** anthracit 144/44/38 cm

Alle Polsterteile in Boucle fresco 772

Alle Holzteile in Nussbaum, geölt

—

Tête de lit **Talma**

Pieds **Tondo** anthracit 20 cm

Table de nuit **Nali** anthracit Ø 48/52 cm

Banquette **Topa** anthracit 144/44/38 cm

Toutes les parties rembourrées en Boucle fresco 772

Toutes les parties en bois en noyer, huilé

—

Headboard **Talma**

Feet **Tondo** anthracit 20 cm

Bedside table **Nali** anthracit Ø 48/52 cm

Bench **Topa** anthracit 144/44/38 cm

All upholstery parts in Boucle fresco 772

All wooden parts in alnut, oiled

Sole 18/3S

Dimension

140, 160, 180, 200 × 200, 210, 220 cm

Kopfteil **Sienna**

Kufen **Skid** 20, 25 cm

Nachttisch **Lina** anthracit Ø 45/52 cm

Lampen (2er Set) **Snake** anthracit

Alle Polsterteile in Fusio shell 750

Alle Holzteile in Eiche bianco, geölt

Tête de lit **Sienna**

Patins **Skid** anthracit 20, 25 cm

Table de nuit **Lina** anthracit Ø 45/52 cm

Lampes (set de 2) **Snake** anthracit

Toutes les parties rembourrées en Fusio shell 750

Toutes les parties en bois en chêne bianco, huilé

Headboard **Sienna**

Vats **Skid** anthracit 20, 25 cm

Bedside table **Lina** anthracit Ø 45/52 cm

Lamps (set of 2) **Snake** anthracit

All upholstery parts in Fusio shell 750

All wooden parts in oak bianco, oiled



Sole 18/4S

Dimension

140, 160, 180, 200 × 200, 210, 220 cm

Kopfteil **Cussina**

Füsse **Arc** 20, 25 cm

Nachttische **Nali** bronze/Eiche bianco Ø 48/52 cm

Kommode **Quatro** anthracit 45/50/86 cm

Alle Polsterteile in Fusio anthracit 751

Alle Holzteile in Eiche bright, geölt

Tête de lit **Cussina**

Pieds **Arc** 20, 25 cm

Table de nuit **Nali** bronze /chêne bianco Ø 48/52 cm

Commode **Quatro** anthracit 45/50/86 cm

Toutes les parties rembourrées en Fusio anthracit 751

Toutes les parties en bois en chêne bright, huilé

Headboard **Cussina**

Feet **Arc** 20, 25 cm

Bedside table **Nali** bronze/oak bianco Ø 48/52 cm

Chest of drawers **Quatro** anthracit 45/50/86 cm

All upholstery parts in Fusio anthracit 751

All wooden parts in oak bright, oiled





Lungo 23/2S

Dimension

90, 100, 120, 140, 160, 180, 200 × 200, 210, 220 cm

Kopfteil/Fussteil **Venus**

Kufen **Slid** anthracit 20, 25 cm

Nachttisch **Twia** anthracit 45/50/41 cm

Lampen (2er Set) **Smart** black + **Combino**

Alle Polsterteile in Boucle mouse 773

Alle Holzteile in Eiche bright, geölt

Tête de lit/pied de lit **Venus**

Patins **Slid** anthracit, 20, 25 cm

Table de nuit **Twia** anthracit 45/50/41 cm

Lampes (set de 2) **Smart** black + **Combino**

Toutes les parties rembourrées en Boucle mouse 773

Toutes les parties en bois en chêne bright, huilé

Headboard/footboard **Venus**

Vats **Slid** anthracit, 20, 25 cm

Bedside table **Twia** anthracit 45/50/41 cm

Chest of drawers **Tola** 50/49/51

Lamps (set of 2) **Smart** black + **Combino**

All upholstery parts in Boucle mouse 773

All wooden parts in oak bright, oiled





Lungo 23/2S

Dimension 140, 160, 180, 200 × 200, 210, 220 cm

Kopfteil/Fussteil **Combia**

Füße **Fasio** bronze 20 cm

Bank **Topa** bronze 144/44/38 cm

Nachttisch **Lina** bronze Ø 45/52 cm

Alle Polsterteile in Fusio musk 752

Alle Holzteile in Nussbaum, geölt

Tête de lit/pied de lit **Combia**

Pieds **Fasio** bronze 20 cm

Banquette **Topa** bronze 144/44/38 cm

Table de nuit **Lina** bronze Ø 45/52 cm

Toutes les parties rembourrées en Fusio musk 752

Toutes les parties en bois en noyer, huilé

Headboard/footboard **Combia**

Feet **Fasio** bronze, 20 cm

Bench **Topa** bronze 144/44/38 cm

Bedside table **Lina** bronze Ø 45/52 cm

All upholstery parts in Fusio musk 752

All wooden parts in oak walnut, oiled



Lungo 23/3S

Dimension

140, 160, 180, 200 × 200, 210, 220 cm

Kopfteil **Zuro M**

Füße **Jeno** anthracit 10, 20, 25 cm

Nachttisch **Onia** anthracit 45/50/41 cm +

Füße **Jone** anthracit 10 cm

Sekretär **Scola** 120/70/72-88

Alle Polsterteile in Echtleder Real falda 513

Alle Holzteile in Akazie Vintage grey

Tête de lit **Zuro M**

Pieds **Jeno** anthracit 10, 20, 25 cm

Table de nuit **Onia** anthracit 45/50/41 cm +

Pieds **Jone** anthracit 10 cm

Secrétaire **Scola** 120/70/72-88

Toutes les parties rembourrées en cuir véritable Real falda 513

Toutes les parties en bois en acacia Vintage grey

Headboard **Zuro M**

Feet **Jeno** anthracit, 10, 20, 25 cm

Bedside table **Onia** anthracit 45/50/41 cm +

Feet **Jone** anthracit 10 cm

Bureau **Scola** 120/70/72-88

All upholstery parts in real leather Real falda 513

All wooden parts in acacia Vintage grey





Lungo 28/2S

Dimension

140, 160, 180, 200 × 200, 210, 220 cm

Kopfteil **Ronio**

Füße **Arc** Eiche bright 20, 25 cm

Nachttisch **Circo 44** Ø 45/44 cm

Sekretär **Aska** 120/60/85 cm

Bank **Sola** Eiche bright 140/37/38 cm + Kissen **Topia**

Lampen (2er Set) **Smart white** + **Combino**

Alle Polsterteile in Capo linen 763

Alle Holzteile in Eiche bianco, geölt

Tête de lit **Ronio**

Pieds **Arc** chêne bright 20, 25 cm

Table de nuit **Circo 44** Ø 45/44 cm

Secrétaire **Aska** 120/60/85 cm

Banquette **Sola** chêne bright 140/37/38 cm + coussin **Topia**

Lampes (set de 2) **Smart white** + **Combino**

Toutes les parties rembourrées en Capo linen 763

Toutes les parties en bois en chêne bianco, huilé

Headboard **Ronio**

Feet **Arc** oak bright 20, 25 cm

Bedside table **Circo 44** Ø 45/44 cm

Bureau **Aska** 120/60/85 cm

Bench **Sola** oak bright 140/37/38 cm + cushion **Topia**

Lamps (set of 2) **Smart white** + **Combino**

All upholstery parts in Capo linen 763

All wooden parts in oak bianco, oiled



Ciara 28/3S

Dimension

140, 160, 180, 200 × 200, 210, 220 cm

Kopfteil **Kimo**

Füsse **Masi** 10, 20, 25 cm

Nachttisch **Noma** 48/43/47 cm + Füsse **Sima 10**

Kommode **Sigma** 120/49/76 cm + Füsse **Sima 10**

Bank **Sola** 140/37/38 cm

Alle Polsterteile in Capo rose 762

Alle Holzteile in Eiche bianco, gebürstet, geölt

Tête de lit **Kimo**

Pieds **Masi** 10, 20, 25 cm

Table de nuit **Noma** 48/43/47 cm+ pieds **Sima 10**

Commode **Sigma** 120/49/76 cm + pieds **Sima 10**

Banquette **Sola** 140/37/38 cm

Toutes les parties rembourrées en Capo rose 762

Toutes les parties en bois en chêne bianco, brossé, huilé

Headboard **Kimo**

Feet **Masi** 10, 20, 25 cm

Bedside table **Noma** 48/43/47 cm+ feet **Sima 10**

Kommode **Sigma** 120/49/76 cm + feet **Sima 10**

Bench **Sola** 140/37/38 cm

All upholstery parts in Capo rose 762

All wooden parts in oak bianco, brushed, oiled





Ciara 28/3S

Dimension

140, 160, 180, 200 × 200, 210, 220 cm

Kopfteil **Damo**

Füsse **Ivio** 10, 20, 25 cm

Alle Polsterteile in Casual olive 333

Alle Holzteile in Nussbaum geölt

—

Tête de lit **Damo**

Pieds **Ivio** 10, 20, 25 cm

Toutes les parties rembourrées en Casual olive 333

Toutes les parties en bois en noyer huilé

—

Headboard **Damo**

Feet **Ivio** 10, 20, 25 cm

All upholstery parts in Casual olive 333

All wooden parts in walnut oiled





Ciara 28/4S

Dimension

90, 100, 120, 140, 160, 180, 200 × 200, 210, 220 cm

Kopfteil **Obag**

Füße **Masi** 10, 20, 25 cm

Nachttisch **Trigo** 48/43/55 cm

Sekretär **Aska** 120/60/85 cm

Alle Polsterteile in Campos blanc 372

Alle Holzteile in Nussbaum, geölt

Tête de lit **Obag**

Pieds **Masi** 10, 20, 25 cm

Table de nuit **Trigo** 48/43/55 cm

Secrétaire **Aska** 120/60/85 cm

Toutes les parties rembourrées en Campos blanc 372

Toutes les parties en bois en noyer, huilé

Headboard **Obag**

Feet **Masi** 10, 20, 25 cm

Bedside table **Trigo** 48/43/47 cm

Bureau **Aska** 120/60/85 cm

All upholstery parts in Campos blanc 372

All wooden parts in walnut, oiled





Silenzio



Betten | Lits | Beds

Silenzio 23

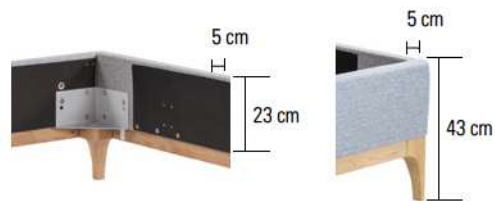

Breiten | Largeurs | Widths:
140, 160, 180, 200 cm

Längen | Longueurs | Lengths:
200, 210, 220 cm

Einlegetiefe | Hauteur encastrable | Insertion depth:
23 cm

Silenzio 28

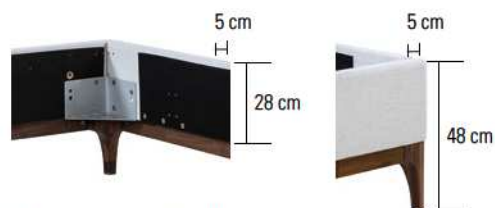

Breiten | Largeurs | Widths:
140, 160, 180, 200 cm

Längen | Longueurs | Lengths:
200, 210, 220 cm

Einlegetiefe | Hauteur encastrable | Insertion depth:
28 cm

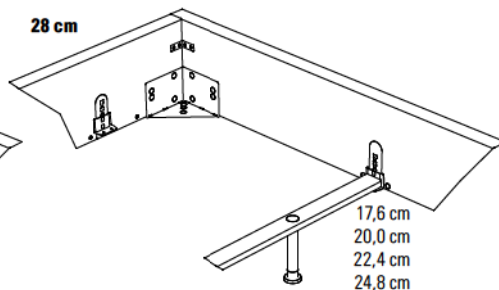
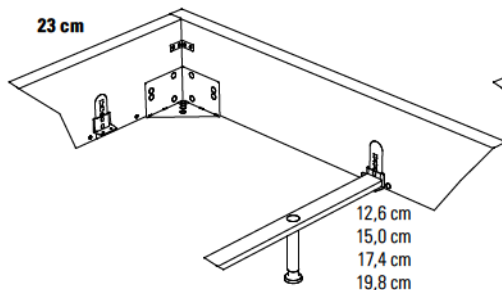

Bei allen Betten Silenzio 23/28 ist die Einlegetiefe in 4 verschiedenen Höhen standardmässig verstellbar. Midtraver-move ist bei allen Betten Silenzio 23/28 ab der Breite 160 cm inklusive.

Tous les lits Silenzio 23/28 ont une profondeur d'insertion réglable de 4 hauteurs différentes en standard. Midtraver-move est incluse avec tous les lits Silenzio 23/28 à partir de 160 cm de largeur.

All Silenzio 23/28 beds have an adjustable insertion depth of 4 different heights as standard. Midtraver-move is included with all Silenzio 23/28 beds from 160 cm width.

Ausführungen | Exécutions | Executions

Holz | Bois | Wood



74
Eiche bright, geölt
Chêne bright, huilé
Oak bright, oiled



82
Nussbaum, geölt
Noyer, huilé
Walnut, oiled

Kopfteile | Têtes de lit | Headboards

Suno

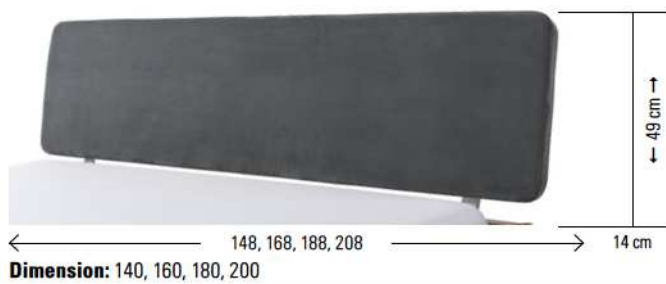

Obag*

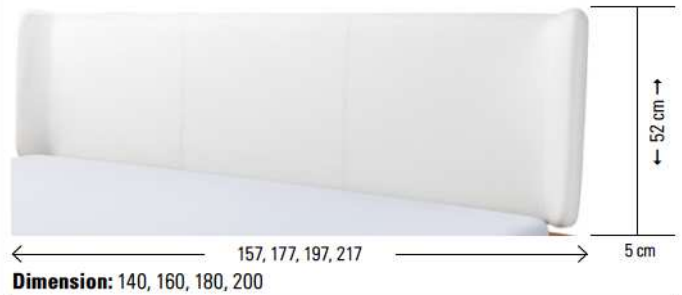

Ripo

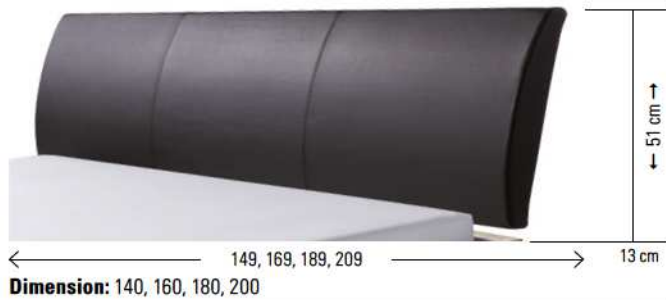

Boga

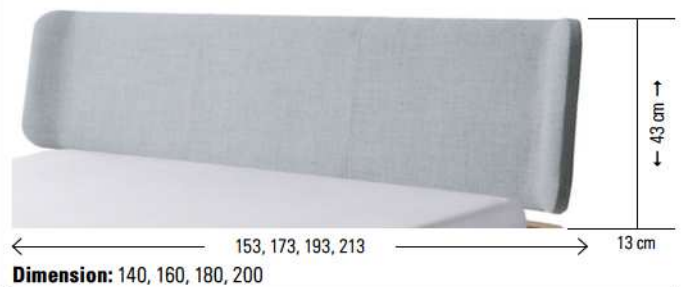

*Leselampen nicht montierbar | Montage de lampes de lecture impossible | No possibility to assemble reading lamps

Vola



Duetto



Kissen zu Kopfteilen | Coussins pour têtes de lit | Cushions for headboards

Arona + Duetto



Lumo + Duetto



Stoffauswahl/Farben für Kissen siehe Gesamtkatalog Register 1, Seiten 1.6–1.7 | Choix de tissus/couleurs pour coussins voir catalogue général registre 1, pages 1.6–1.7 | Choice of tissues/colours for cushions see general catalogue index 1, pages 1.6–1.7

Adapter | Adaptateur | Adapter

Bei hohen Matratzen kann mit dem Verlängerungsadapter das Kopfteil um 9 oder 13 cm erhöht werden.

La tête de lit peut être rehaussée de 9 ou 13 cm avec l'adaptateur quand le matelas est plus épais. With the extension adapter the headboard can be extended 9 or 13 cm if mattresses are high.

Head-Plus Metall | Métal | Metal

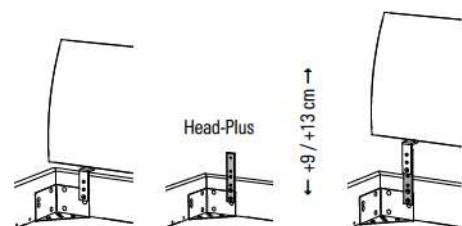

Silenzio 23 + 28

Dimension

140, 160, 180, 200 × 200, 210, 220 cm

Kopfteil **Vola**

Nachttisch **Noma** 48/43/55 cm

Alle Polsterteile in Kitana grigio 602

Alle Holzteile in Eiche bianco, geölt

Tête de lit **Vola**

Table de nuit **Noma** 48/43/55 cm

Toutes les parties rembourrées en Kitana grigio 602

Toutes les parties en chêne bianco, huilé

Headboard **Vola**

Bedside table **Noma** 48/43/55 cm

All upholstery parts in Kitana grigio 602

All wooden parts in oak bianco, oiled





Silenzio 23 + 28

Dimension

140, 160, 180, 200 × 200, 210, 220 cm

Kopfteil **Obag**

Nachttisch **Trigo** 48/43/55 cm

Sekretär **Aska** 120/60/85 cm

Alle Polsterteile in Capo linen 763

Alle Holzteile in Nussbaum, geölt

–

Tête de lit **Obag**

Table de nuit **Trigo** 48/43/55 cm

Secrétaire **Aska** 120/60/85 cm

Toutes les parties rembourrées en Capo linen 763

Toutes les parties en bois en noyer, huilé

–

Headboard **Obag**

Bedside table **Trigo** 48/43/55 cm

Bureau **Aska** 120/60/85 cm

All upholstery parts in Capo linen 763

All wooden parts in walnut, oiled







Bei Bettbreite 160 und 180 cm Midtraver-move inklusive!

Pour une largeur de lit de 160 et 180 cm Midtraver-move inclus!
For bed width 160 and 180 cm Midtraver-move included!

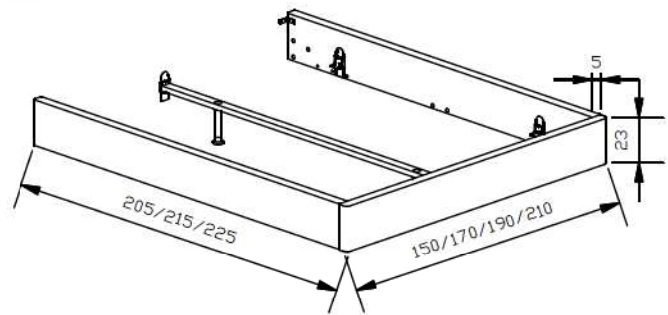
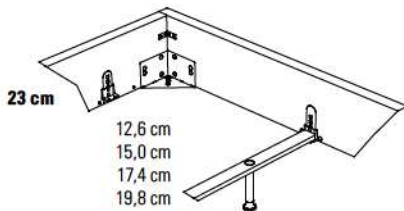

Bei allen Betten von Dream pronto ist die Einlegetiefe in vier verschiedenen Höhen standardmässig verstellbar.

Tous les lits Dream pronto ont une profondeur d'insertion réglable de 4 hauteurs différentes en standard.
All Dream pronto beds have an adjustable insertion depth of 4 different heights as standard.



Holzfüsse und Kopfteilblenden in den Holz- ausführungen:

Pieds en bois et panneaux de tête de lit dans les finitions en bois :
Wooden feet and headboard trims in the wood versions:

Holz | Bois | Wood



74
Eiche bright, geölt
Chêne bright, huilé
Oak bright, oiled



82
Nussbaum, geölt
Noyer, huilé
Walnut, oiled



87
Wildbuche natur, geölt
Hêtre nouveau naturel, huilé
Wildbeech natural, oiled



99
Wildeiche natur, geölt
Chêne nouveau naturel, huilé
Wildoak naturel, oiled

Stoffauswahl | Choix de tissus | Choice of fabrics



327 Pepe beige



335 Pepe grey



720 Buffalo shale



721 Buffalo grey

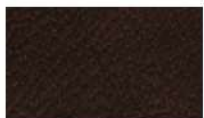

722 Buffalo espresso



770 Boucle ivory

Pepe kann chemisch gereinigt werden. Die abgebildeten Farben können von den Originalfarben und Strukturen abweichen.

Nous conseillons un nettoyage à sec pour le tissu Pepe. Les couleurs et les structures des illustrations peuvent être différentes des couleurs et des structures originales.

The fabric Pepe can be dry cleaned. The illustrated colours can be different than the original colours and structures.

LIEFERUNG

Livraison à partir du stock **AB LAGER**
Delivery from stock



*schnell,
zuverlässig,
ab Lager*

**rapide, fiable, à partir du stock
quick, reliable, from stock**

Mit unserem Schnellieferservice «PRONTO» können wir eine grosse Auswahl an Betten mit Beimöbeln und alle Modelle aus Edition Pronto (Register 4) und Dream pronto (Register 12) ab Lager liefern.

Die betreffenden Modelle sind in unserer Preisliste mit einem roten Punkt vor der Artikelnummer gekennzeichnet.

Notre service de livraison rapide « PRONTO » permet de livrer un large choix de lits et de meubles d'appoint et tous les modèles des éditions Pronto (registre 4) et Dream Pronto (registre 12) à partir du stock.

Les modèles concernés sont signalés par un point rouge devant le numéro d'article dans notre liste de prix.

With our quick delivery service «PRONTO» a huge selection of beds with side furniture and all models from Edition Pronto (index 4) and Dream Pronto (index 12) can be delivered from stock.

The respective models are marked in our pricelist with a red dot in front of the article number.



Noah 20 + 25

Dimension

140, 160, 180 × 200 cm

Füsse 20, 25 cm

Nachttisch **Twia** anthracit 45/50/41 cm

Alle Polsterteile in Buffalo shale 720

Alle Holzteile in Nussbaum, geölt

—

Pieds 20, 25 cm

Table de nuit **Twia** anthracit 45/50/41 cm

Toutes les parties rembourrées en Buffalo shale 720

Toutes les parties en bois en noyer, huilé

—

Feet 20, 25 cm

Bedside table **Twia** anthracit 45/50/41 cm

All upholstery parts in Buffalo shale 720

All wooden parts in walnut, oiled





Noemi 20 + 25

Dimension
140, 160, 180 × 200 cm

Füsse 20, 25 cm
Nachttisch **Dowe** weiss 45/50/55 cm

Alle Polsterteile in Pepe beige 327
Alle Holzteile in Eiche bianco, geölt

Pieds 20, 25 cm
Table de nuit **Dowe** blanc 45/50/55 cm

Toutes les parties rembourrées en Pepe beige 327
Toutes les parties en chêne bianco, huilé

Feet 20, 25 cm
Bedside table **Dowe** white 45/50/55 cm

All upholstery parts in Pepe beige 327
All wooden parts in oak bianco, oiled





MOVIE-/TOP LINE



FACTORY LINE



WOOD LINE



LOUNGE



FINE LINE



NATURO LINE



OAK LINE



OAK WILD



DREAM LINE



**EDITION
BOXSPRING**



**FUNCTION/COMFORT
KIDS & GUESTS**



**LATTENROSTE &
MATRATZEN**



Gesamtkatalog
Catalogue général
General catalogue